

Figure 1-2

Step 3

Tick “I have read and agree”, select operating country and click “Change”. The system displays the following interface, as shown in Figure 1-3.

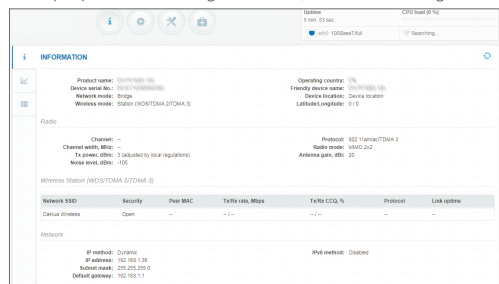

Figure 1-3

Wireless Access Point Configuration:

Step 4

Click “Settings > Wireless Configuration”, as shown in Figure 1-4. Set frequency and channel; set the wireless operating mode to be Access Point (auto WDS). There are 5 operating modes: Access Point (auto WDS),

Wireless Access Point (TDMA2), Access Point (TDMA3), Station (WDS/TDMA2/TDMA3) and Wireless Client (ARPNAT). Click setting icon at the lower right corner of SSID, set SSID and security info, and click “Done”, as shown in Figure 1-5.

Note

- The device connected with camera is set to be “Station (WDS/TDMA2/TDMA3)” mode.
- The device connected with machine room is set to be “Access Point (Auto WDS)” mode.
- Wireless client with “Client(ARPNAT)” mode is used with access point that doesn’t support standard WDS mode.
- Please select WDS mode for transparent transmission of data.

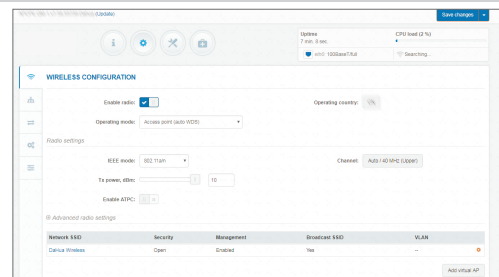

Figure 1-4

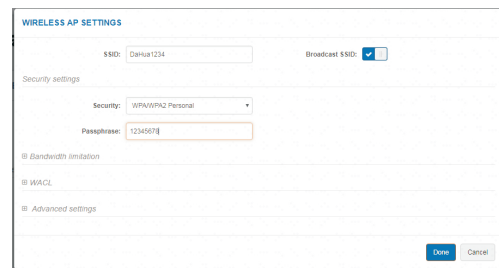

Figure 1-5

Step 5

Click “Save Changes” at the top right corner as shown in Figure 1-6, and then click “Save” as shown in Figure 1-7.

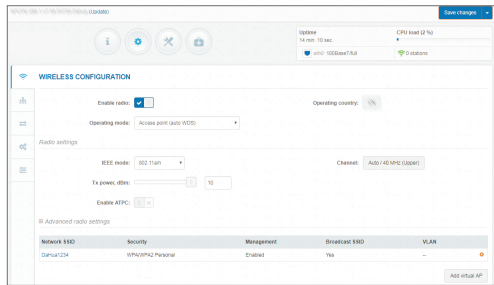

Figure 1-6

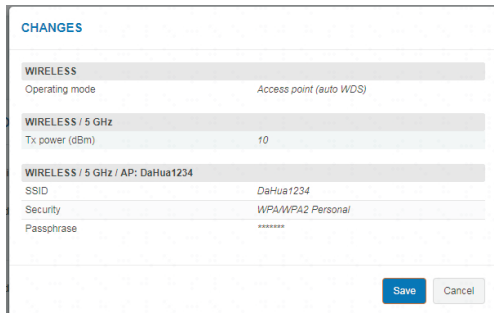

Figure 1-7

Station Configuration

Step 6

Click “Settings > Wireless Configuration”, as shown in Figure 1-8; select operating mode to be “Station (WDS/TDMA2/TDMA3)”. Click setting icon at the lower right corner of SSID, as shown in Figure 1-9. Click “Refresh” icon at the top right corner. Search SSID of access point, click “Select”, enter SSID passphrase and click “Done”, as shown in Figure 1-10.

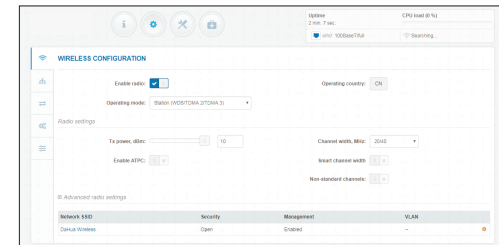

Figure 1-8

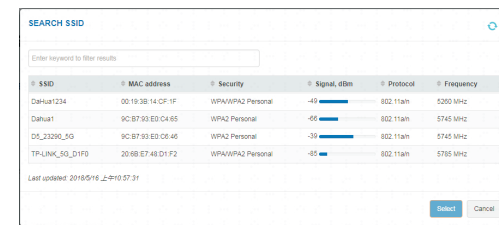

Figure 1-9

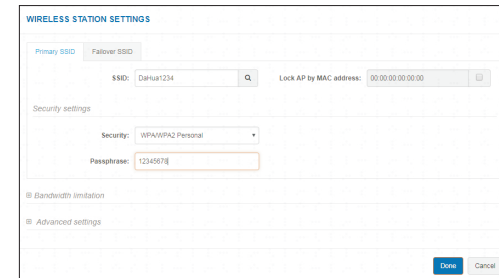

Figure 1-10

Step 7

Select “Network Configuration”, and modify IP address to be 192.168.1.37 as shown in Figure 1-11, in order to avoid IP conflict. Click “Save” at the

top right corner, as shown in Figure 1-12, and click “Done”. It displays normal connection status, as shown in Figure 1-13.

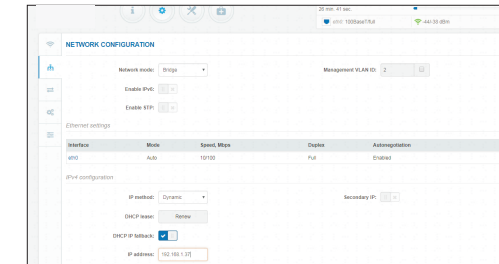

Figure 1-11

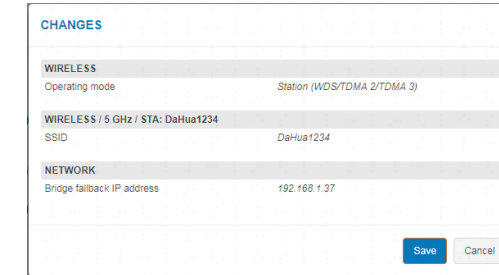

Figure 1-12

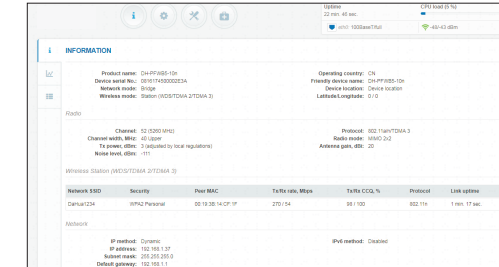

Figure 1-13

Important Safeguards and Warnings

The following description is the correct application method of the device. Please read the manual carefully before use, in order to prevent danger and property loss. Strictly conform to the manual during application and keep it properly after reading.

Operating Requirement

- Please don’t drip or splash liquids onto the device; don’t put on the device anything filled with liquids, in order to prevent liquids from flowing into the device.
- Use the device only within rated input and output range.
- Please don’t dismantle the device arbitrarily.
- Please transport, use and store the device within allowed humidity and temperature range.

About this Document

- The Manual is for reference only. If there is inconsistency between the Manual and the actual product, the actual product shall prevail.
- We are not liable for any loss caused by the operations that do not comply with the Manual.
- The Manual would be updated according to the latest laws and regulations of related regions. For detailed information, see the paper User’s Manual, CD-ROM, QR code or our official website. If there is inconsistency between paper User’s Manual and the electronic version, the electronic version shall prevail.
- All the designs and software are subject to change without prior written notice. The product updates might cause some differences between the actual product and the Manual. Please contact the customer service for the latest program and supplementary documentation.
- There still might be deviation in technical data, functions and operations description, or errors in print. If there is any doubt or dispute, please refer to our final explanation.
- Upgrade the reader software or try other mainstream reader software if the Guide (in PDF format) cannot be opened.

PFWB2-90n&PFWB5-90n&PFWB5-90ac

INSTALLATION

Package content

DH-PFWB2-90n&DH-PFWB5-90n&DH-PFWB5-90ac

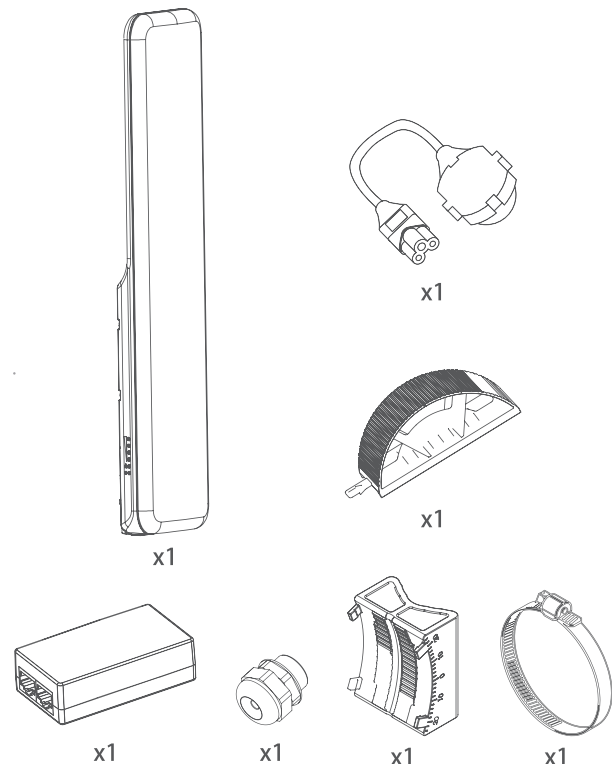

Mounting

DH-PFWB2-90n&DH-PFWB5-90n&DH-PFWB5-90ac

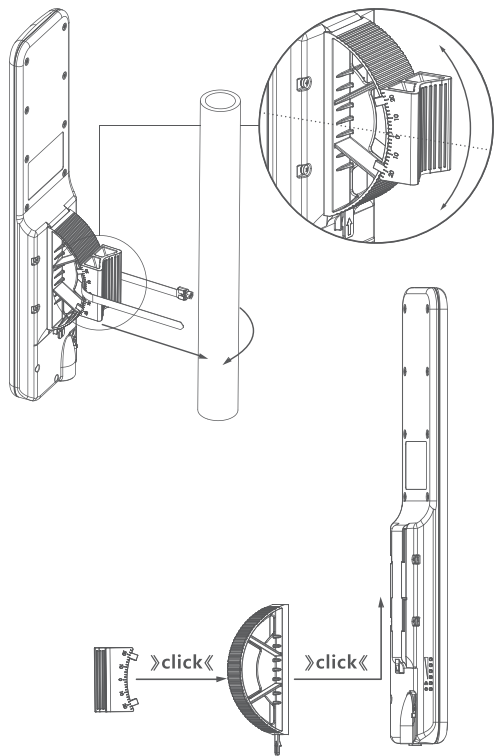

Overview

DH-PFWB2-90n&DH-PFWB5-90n&DH-PFWB5-90ac

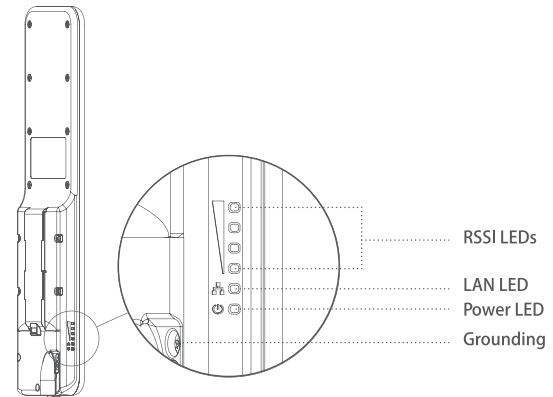

PoE connection

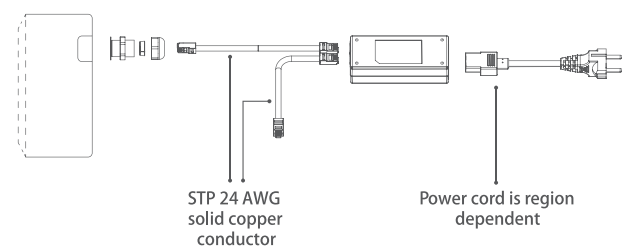

Note

Installation Requirements
Shielded Category 5 (or above) cabling should be used for all wired Ethernet connections and grounded through AC ground of PoE. For all outdoor installations, we recommend that you use Ethernet Surge Protectors near the device, which will absorb power surges and discharge them into the ground.

Default Login settings

IP address:	Login
DHCP client	Username: admin
(Fallback IP 192.168.1.36)	Password: admin

Parameters

Model name	PFWB2-90n	PFWB5-90n	PFWB5-90ac
Frequency	2.402-2.492GHz	5.150-5.850GHz	5.150-5.850GHz
Tx power	Up to 31 dBm (country dependent)	Up to 29 dBm (country dependent)	Up to 30 dBm (country dependent)
EIRP	47 dBm (country dependent)	47 dBm (country dependent)	48 dBm (country dependent)
Antenna gain	16 dBi	18 dBi	18 dBi
Power supply	24V DC passive PoE	24V DC passive PoE	24V DC passive PoE
Power consumption	4.5W	4.5W	10W

Configuration Steps

Precondition

- Please ensure that PC has been connected with LAN port of PoE power of wireless device.
- IP address of PC and IP address of the device (default one is **192.168.1.36**) are set to be in the same network segment.

Operating Steps

Step 1

Open Internet Explorer, input default IP address of wireless device in the address bar and press [Enter] key.

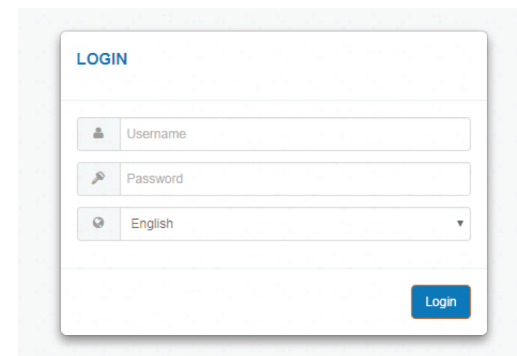

Figure 1-1

Step 2

Input the username and password, and click "Login". The system displays the following interface, as shown in Figure 1-2.

Note

Default username and password are admin. It is suggested that a password with high security should be set and password should be modified regularly.